

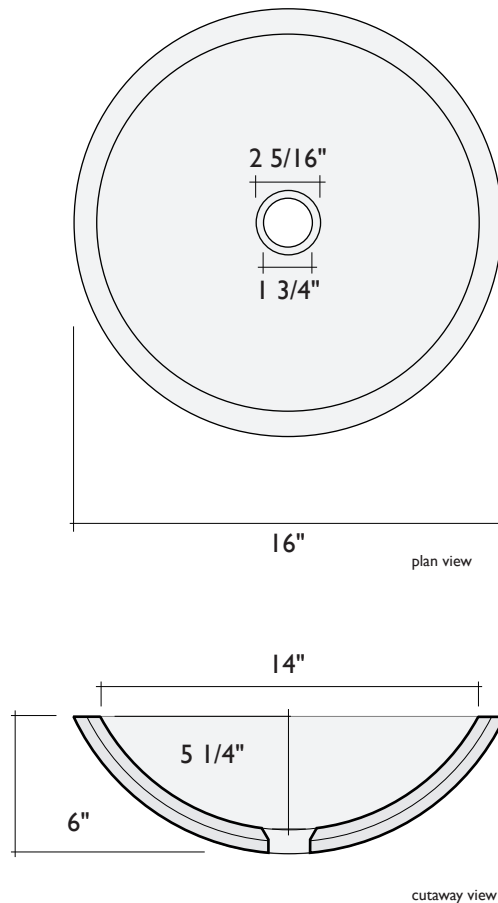

SPECIFICATIONS: SINKS (CAST BRONZE):

BRONZE SINK



ITEM NUMBERS:

Cast
Bronze
Sink



ABI243.86

Solid Bronze

NOTES: The Bronze sink is cast in solid bronze to roughly 3/4" thickness. Outer surface is textured while the inner surface is polished and buffed. Sink is finished with a rich bronze patina and then waxed. The sink includes a strainer drain cap assembly in matching bronze patina. See "Bronze Sink Care Instructions" for more information.

ALCHEMY
GLASS & LIGHT
www.alchemyglass.com



SPECIFICATIONS: STONE COUNTERTOP (CARVED CENTER):

STANDARD SIZE ROUGH-HEWN 3 1/2" THICK

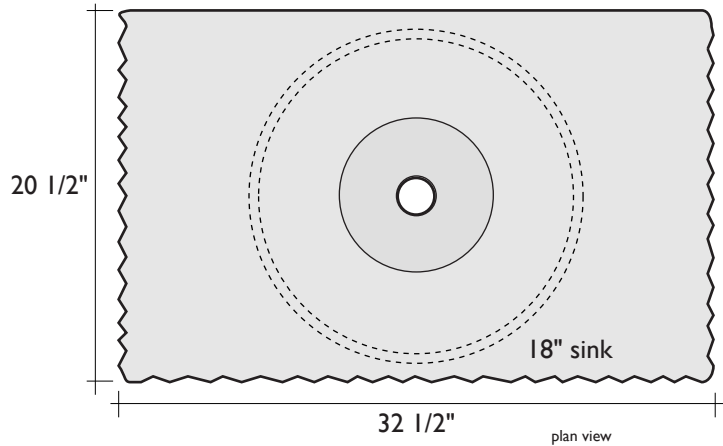
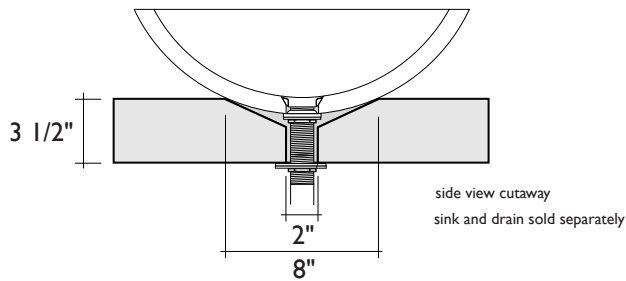
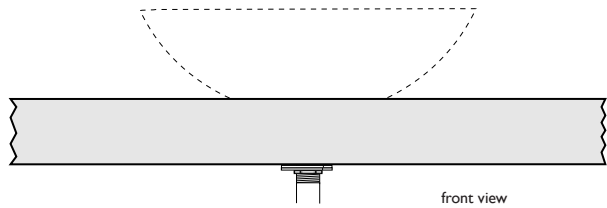

SMALLER SIZE HONED 2" THICK

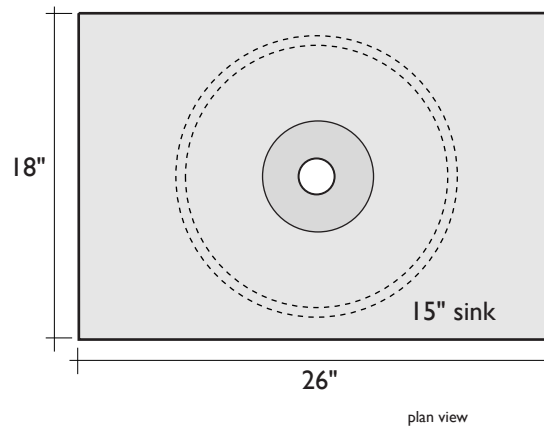
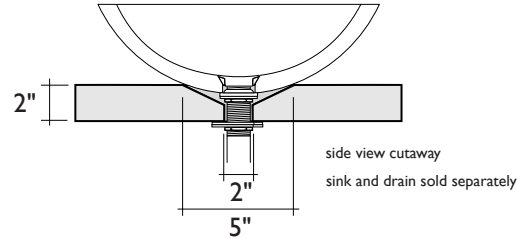
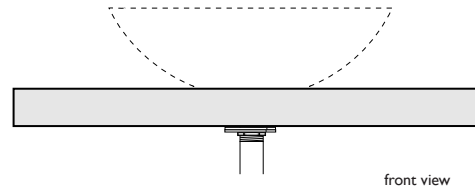

ITEM NUMBERS:

3 1/2" Rough-Hewn

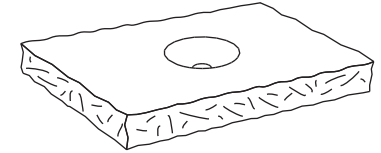

AB2161.87 32 1/2" x 20 1/2"

2" Honed

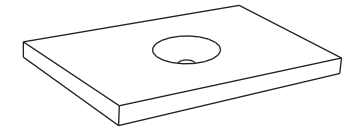

AB2262.88 26" x 18"

Alchemy also offers steel vanity bases designed specifically for these stone tops. See "Steel Vanity Base Specifications" for more info.

NOTES: These countertops are French Limestone, a light cream colored porous stone with slight veining. Stones are sealed after carving to protect from spot staining. The larger stone with rough-hewn edge has a coarser grain and small pieces may flake off the roughened edges. The smaller stone has a denser structure that allows the surfaces to be honed to a smooth flat finish. Both have carved out center areas to support our above-counter round sinks. Countertops are supplied with a C-Washer and extra nut for sink installation with an Alchemy drain assembly (see "C-Washer & Stone Countertop Installation Instructions" for more info). No mounting ring is needed with this type of countertop.

ALCHEMY
GLASS & LIGHT

www.alchemyglass.com



SPECIFICATIONS: STEEL VANITY BASE (FOR STONE TOPS):

STANDARD SIZE (FOR 32X20 COUNTERTOP)

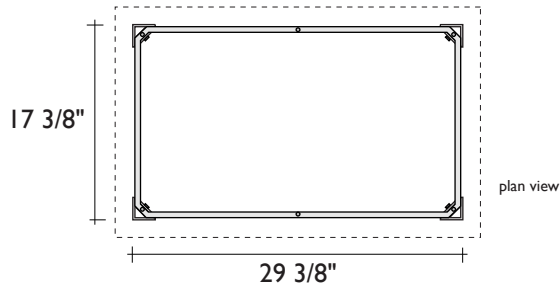

SMALLER SIZE (FOR 26X18 COUNTERTOP)

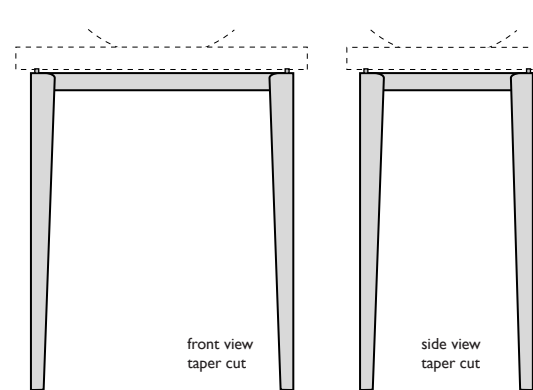
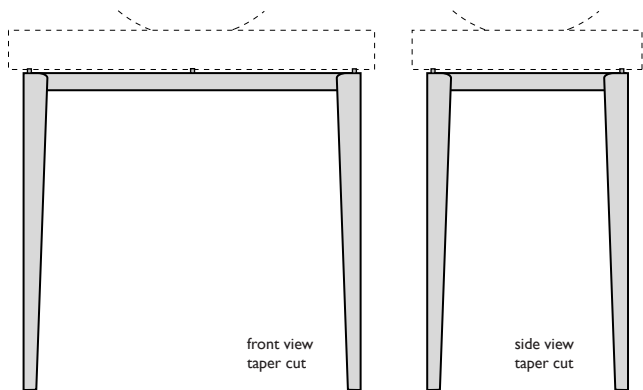
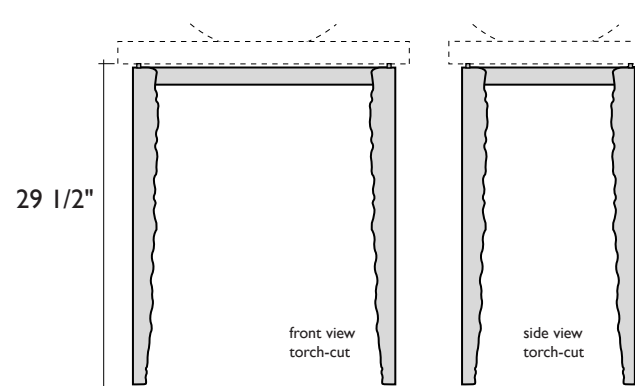
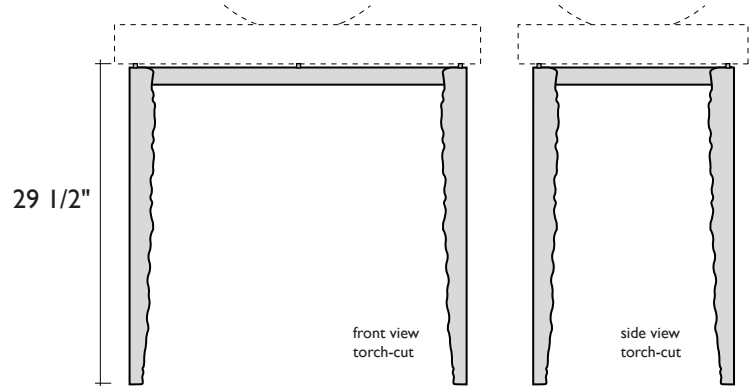
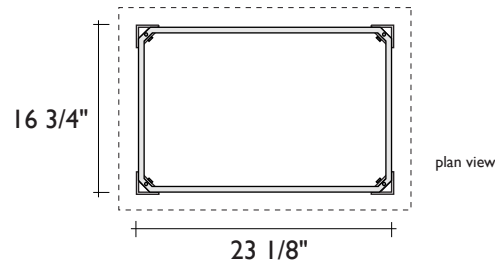

ITEM NUMBERS:

Standard Size
Torch-Cut Legs



AB3376.67 Dark Bronze Patina

Standard Size
Taper Cut Legs



AB3377.67 Dark Bronze Patina

Smaller Size
Torch-Cut Legs



AB3476.67 Dark Bronze Patina

Smaller Size
Taper Cut Legs



AB3477.67 Dark Bronze Patina

NOTES: The Steel Vanity base is available with either Torch-Cut or straight Taper-Cut Legs that bolt on to a welded frame. It's designed to support Alchemy's stone countertops. The pieces are patinaed to a rich very dark brown and sealed with clear lacquer. Rubber bumpers threaded into the frame support the stone countertop. Custom sizes are available. For more information on assembling this vanity base, see "Steel Vanity Assembly Instructions."

ALCHEMY
GLASS & LIGHT
www.alchemyglass.com